

INSTRUCTION MANUAL

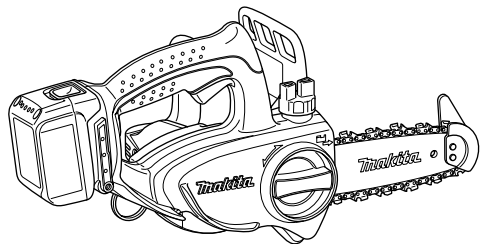

# Cordless Chain Saw

**BUC121**  
**BUC122**



008563

**IMPORTANT:** Read Before Using.

## ENGLISH (Original instructions)

# SPECIFICATIONS

Model	BUC121	BUC122
Chain speed per minute (min <sup>-1</sup> )	4.8 m/s (290 m/min)	5.0 m/s (300 m/min)
Length of guide bar	115 mm	
Saw chain	Type	25 AP
	Pitch	1/4"
	No. of drive links	42
Overall length	422mm	422mm
Net weight	2.5 kg	2.6 kg
Rated voltage	D.C. 14.4 V	D.C. 18 V

- Due to our continuing programme of research and development, the specifications herein are subject to change without notice.
- Specifications and battery cartridge may differ from country to country.
- Weight, with battery cartridge, according to EPTA-Procedure 01/2003

END005-3

ENE031-1

## Symbols

The following show the symbols used for the equipment. Be sure that you understand their meaning before use.



- Read instruction manual.



- Wear eye protection.



- Wear ear protection.



- Wear a helmet, goggles and ear protection.



- Use appropriate protection for foot-leg and hand-arm.



- Do not expose to rain.



- Hold the saw with both hands while working! One-handed use is extremely hazardous!



- This saw is to be used by properly trained operators only.



- Only for EU countries



- Do not dispose of electric equipment or battery pack together with household waste material!

In observance of European Directive 2002/96/EC on waste electric and electronic equipment, 2006/66/EC on batteries and accumulators and waste batteries and accumulators and their implementation in accordance with national laws, electric equipment and battery pack that have reached the end of their life must be collected separately and returned to an environmentally compatible recycling facility.

## Intended use

The tool is intended for cutting lumbers and logs.

## For Model BUC121

ENG102-3

## Noise

The typical A-weighted noise level determined according to EN60745:

Sound pressure level ( $L_{pA}$ ) : 84 dB(A)

Sound power level ( $L_{WA}$ ) : 92 dB(A)

Uncertainty (K) : 2 dB(A)

## Wear ear protection

ENG221-3

## Vibration

The vibration total value (tri-axial vector sum) determined according to EN60745:

Work mode : cutting wood

Vibration emission ( $a_h$ ) : 4.2 m/s<sup>2</sup>

Uncertainty (K) : 1.5 m/s<sup>2</sup>

- The declared vibration emission value has been measured in accordance with the standard test method and may be used for comparing one tool with another.
- The declared vibration emission value may also be used in a preliminary assessment of exposure.

## ⚠WARNING:

- The vibration emission during actual use of the power tool can differ from the declared emission value depending on the ways in which the tool is used.
- Be sure to identify safety measures to protect the operator that are based on an estimation of exposure in the actual conditions of use (taking account of all parts of the operating cycle such as

the times when the tool is switched off and when it is running idle in addition to the trigger time).

#### For Model BUC122

ENG102-3

#### Noise

The typical A-weighted noise level determined according to EN60745:

Sound pressure level ( $L_{pA}$ ) : 84.6 dB(A)

Sound power level ( $L_{WA}$ ) : 92.7 dB(A)

Uncertainty (K) : 2 dB(A)

#### Wear ear protection

ENG221-3

#### Vibration

The vibration total value (tri-axial vector sum) determined according to EN60745:

Work mode : cutting wood

Vibration emission ( $a_h$ ) : 4.3 m/s<sup>2</sup>

Uncertainty (K) : 1.5 m/s<sup>2</sup>

- The declared vibration emission value has been measured in accordance with the standard test method and may be used for comparing one tool with another.
- The declared vibration emission value may also be used in a preliminary assessment of exposure.

#### WARNING:

- The vibration emission during actual use of the power tool can differ from the declared emission value depending on the ways in which the tool is used.
- Be sure to identify safety measures to protect the operator that are based on an estimation of exposure in the actual conditions of use (taking account of all parts of the operating cycle such as the times when the tool is switched off and when it is running idle in addition to the trigger time).

ENH026-4

#### For European countries only

#### EC Declaration of Conformity

**We Makita Corporation as the responsible manufacturer declare that the following Makita machine(s):**

Designation of Machine:  
Cordless Chain Saw

Model No./ Type: BUC121

Specifications: see "SPECIFICATIONS" table.

are of series production and

#### Conforms to the following European Directives:

2000/14/EC, 2006/42/EC

And are manufactured in accordance with the following standards or standardised documents:

EN60745, EN/ISO11681

The EC-Type Examination Certificate No.M6T 09 10 24243 110

The EC-Type Examination per 98/37/EC and 2006/42/EC was performed by:

TÜV SÜD Product Service GmbH,  
Ridlerstraße 65, 80339 MÜNCHEN, Germany  
Identification No. 0123

The technical documentation is kept by our authorised representative in Europe who is:

Makita International Europe Ltd,  
Michigan, Drive, Tongwell,  
Milton Keynes,Bucks MK15 8JD, England

The conformity assessment procedure required by Directive 2000/14/EC was in Accordance with annex V.

Measured Sound Power Level: 92.0dB

Guaranteed Sound Power Level: 94.0dB

4th November 2009



000230

Tomoyasu Kato  
Director

Makita Corporation  
3-11-8, Sumiyoshi-cho,  
Anjo, Aichi, JAPAN

ENH026-4

#### For European countries only

#### EC Declaration of Conformity

**We Makita Corporation as the responsible manufacturer declare that the following Makita machine(s):**

Designation of Machine:  
Cordless Chain Saw

Model No./ Type: BUC122

Specifications: see "SPECIFICATIONS" table.

are of series production and

#### Conforms to the following European Directives:

2000/14/EC, 2006/42/EC

And are manufactured in accordance with the following standards or standardised documents:

EN60745, EN/ISO11681

The EC-Type Examination Certificate No.M6T 09 10 24243 110

The EC-Type Examination per 98/37/EC and 2006/42/EC was performed by:

TÜV SÜD Product Service GmbH,  
Ridlerstraße 65, 80339 MÜNCHEN, Germany  
Identification No. 0123

The technical documentation is kept by our authorised representative in Europe who is:

Makita International Europe Ltd,  
Michigan, Drive, Tongwell,

Milton Keynes, Bucks MK15 8JD, England  
The conformity assessment procedure required by  
Directive 2000/14/EC was in Accordance with annex V.  
Measured Sound Power Level: 93.0dB  
Guaranteed Sound Power Level: 95.0dB

4th November 2009



000230

Tomoyasu Kato  
Director  
Makita Corporation  
3-11-8, Sumiyoshi-cho,  
Anjo, Aichi, JAPAN

GEA006-2

## General Power Tool Safety

### Warnings

**⚠ WARNING** Read all safety warnings and all instructions. Failure to follow the warnings and instructions may result in electric shock, fire and/or serious injury.

### Save all warnings and instructions for future reference.

The term "power tool" in the warnings refers to your mains-operated (corded) power tool or battery-operated (cordless) power tool.

#### Work area safety

1. **Keep work area clean and well lit.** Cluttered or dark areas invite accidents.
2. **Do not operate power tools in explosive atmospheres, such as in the presence of flammable liquids, gases or dust.** Power tools create sparks which may ignite the dust or fumes.
3. **Keep children and bystanders away while operating a power tool.** Distractions can cause you to lose control.

#### Electrical safety

4. **Power tool plugs must match the outlet. Never modify the plug in any way. Do not use any adapter plugs with earthed (grounded) power tools.** Unmodified plugs and matching outlets will reduce risk of electric shock.
5. **Avoid body contact with earthed or grounded surfaces such as pipes, radiators, ranges and refrigerators.** There is an increased risk of electric shock if your body is earthed or grounded.
6. **Do not expose power tools to rain or wet conditions.** Water entering a power tool will increase the risk of electric shock.

7. **Do not abuse the cord. Never use the cord for carrying, pulling or unplugging the power tool. Keep cord away from heat, oil, sharp edges or moving parts.** Damaged or entangled cords increase the risk of electric shock.
8. **When operating a power tool outdoors, use an extension cord suitable for outdoor use.** Use of a cord suitable for outdoor use reduces the risk of electric shock.
9. **If operating a power tool in a damp location is unavoidable, use a ground fault circuit interrupter (GFCI) protected supply.** Use of an GFCI reduces the risk of electric shock.

#### Personal safety

10. **Stay alert, watch what you are doing and use common sense when operating a power tool. Do not use a power tool while you are tired or under the influence of drugs, alcohol or medication.** A moment of inattention while operating power tools may result in serious personal injury.
11. **Use personal protective equipment. Always wear eye protection.** Protective equipment such as dust mask, non-skid safety shoes, hard hat, or hearing protection used for appropriate conditions will reduce personal injuries.
12. **Prevent unintentional starting. Ensure the switch is in the off-position before connecting to power source and/or battery pack, picking up or carrying the tool.** Carrying power tools with your finger on the switch or energising power tools that have the switch on invites accidents.
13. **Remove any adjusting key or wrench before turning the power tool on.** A wrench or a key left attached to a rotating part of the power tool may result in personal injury.
14. **Do not overreach. Keep proper footing and balance at all times.** This enables better control of the power tool in unexpected situations.
15. **Dress properly. Do not wear loose clothing or jewellery. Keep your hair, clothing, and gloves away from moving parts.** Loose clothes, jewellery or long hair can be caught in moving parts.
16. **If devices are provided for the connection of dust extraction and collection facilities, ensure these are connected and properly used.** Use of dust collection can reduce dust-related hazards.

#### Power tool use and care

17. **Do not force the power tool. Use the correct power tool for your application.** The correct power tool will do the job better and safer at the rate for which it was designed.

18. **Do not use the power tool if the switch does not turn it on and off.** Any power tool that cannot be controlled with the switch is dangerous and must be repaired.
19. **Disconnect the plug from the power source and/or the battery pack from the power tool before making any adjustments, changing accessories, or storing power tools.** Such preventive safety measures reduce the risk of starting the power tool accidentally.
20. **Store idle power tools out of the reach of children and do not allow persons unfamiliar with the power tool or these instructions to operate the power tool.** Power tools are dangerous in the hands of untrained users.
21. **Maintain power tools. Check for misalignment or binding of moving parts, breakage of parts and any other condition that may affect the power tool's operation. If damaged, have the power tool repaired before use.** Many accidents are caused by poorly maintained power tools.
22. **Keep cutting tools sharp and clean.** Properly maintained cutting tools with sharp cutting edges are less likely to bind and are easier to control.
23. **Use the power tool, accessories and tool bits etc. in accordance with these instructions, taking into account the working conditions and the work to be performed.** Use of the power tool for operations different from those intended could result in a hazardous situation.

#### **Battery tool use and care**

24. **Recharge only with the charger specified by the manufacturer.** A charger that is suitable for one type of battery pack may create a risk of fire when used with another battery pack.
25. **Use power tools only with specifically designated battery packs.** Use of any other battery packs may create a risk of injury and fire.
26. **When battery pack is not in use, keep it away from other metal objects, like paper clips, coins, keys, nails, screws or other small metal objects, that can make a connection from one terminal to another.** Shorting the battery terminals together may cause burns or a fire.
27. **Under abusive conditions, liquid may be ejected from the battery; avoid contact. If contact accidentally occurs, flush with water. If liquid contacts eyes, additionally seek medical help.** Liquid ejected from the battery may cause irritation or burns.

#### **Service**

28. **Have your power tool serviced by a qualified repair person using only identical replacement parts.** This will ensure that the safety of the power tool is maintained.

29. **Follow instruction for lubricating and changing accessories.**
30. **Keep handles dry, clean and free from oil and grease.**

GEB039-2

## **Cordless Chain saw safety warnings:**

1. **Keep all parts of the body away from the saw chain when the chain saw is operating. Before you start the chain saw, make sure the saw chain is not contacting anything.** A moment of inattention while operating chain saws may cause entanglement of your clothing or body with the saw chain.
2. **Always hold the chain saw with your right hand on the rear handle and your left hand on the front handle.** Holding the chain saw with a reversed hand configuration increases the risk of personal injury and should never be done.
3. **Hold the power tool by insulated gripping surfaces only, because the saw chain may contact hidden wiring.** Saw chains contacting a "live" wire may make exposed metal parts of the power tool "live" and could give the operator an electric shock.
4. **Wear safety glasses and hearing protection. Further protective equipment for head, hands, legs and feet is recommended.** Adequate protective clothing will reduce personal injury by flying debris or accidental contact with the saw chain.
5. **Do not operate a chain saw in a tree.** Operation of a chain saw while up in a tree may result in personal injury.
6. **Always keep proper footing and operate the chain saw only when standing on fixed, secure and level surface.** Slippery or unstable surfaces such as ladders may cause a loss of balance or control of the chain saw.
7. **When cutting a limb that is under tension be alert for spring back.** When the tension in the wood fibres is released the spring loaded limb may strike the operator and/or throw the chain saw out of control.
8. **Use extreme caution when cutting brush and saplings.** The slender material may catch the saw chain and be whipped toward you or pull you off balance.
9. **Carry the chain saw by the front handle with the chain saw switched off and away from your body. When transporting or storing the chain saw always fit the guide bar cover.** Proper handling of the chain saw will reduce the likelihood of accidental contact with the moving

saw chain.

10. **Follow instructions for lubricating, chain tensioning and changing accessories.** Improperly tensioned or lubricated chain may either break or increase the chance for kickback.
11. **Keep handles dry, clean, and free from oil and grease.** Greasy, oily handles are slippery causing loss of control.
12. **Cut wood only. Do not use chain saw for purposes not intended. For example: do not use chain saw for cutting plastic, masonry or non-wood building materials.** Use of the chain saw for operations different than intended could result in a hazardous situation.
13. **Causes and operator prevention of kickback:**

Kickback may occur when the nose or tip of the guide bar touches an object, or when the wood closes in and pinches the saw chain in the cut.

Tip contact in some cases may cause a sudden reverse reaction, kicking the guide bar up and back towards the operator.

Pinching the saw chain along the top of the guide bar may push the guide bar rapidly back towards the operator.

Either of these reactions may cause you to lose control of the saw which could result in serious personal injury. Do not rely exclusively upon the safety devices built into your saw. As a chain saw user, you should take several steps to keep your cutting jobs free from accident or injury.

Kickback is the result of tool misuse and/or incorrect operating procedures or conditions and can be avoided by taking proper precautions as given below:

- Maintain a firm grip, with thumbs and fingers encircling the chain saw handles, with both hands on the saw and position your body and arm to allow you to resist kickback forces. Kickback forces can be controlled by the operator, if proper precautions are taken. Do not let go of the chain saw.

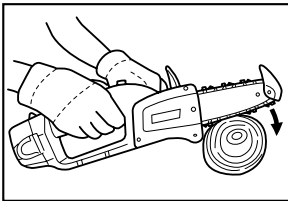

001743

- **Do not overreach and do not cut above shoulder height.** This helps prevent unintended tip contact and enables better control of the chain saw in unexpected

situations.

- **Only use replacement bars and chains specified by the manufacturer.** Incorrect replacement bars and chains may cause chain breakage and/or kickback.
- **Follow the manufacturer's sharpening and maintenance instructions for the saw chain.** Decreasing the depth gauge height can lead to increased kickback.

## SAVE THESE INSTRUCTIONS.

### ⚠WARNING:

**DO NOT** let comfort or familiarity with product (gained from repeated use) replace strict adherence to safety rules for the subject product. **MISUSE or failure to follow the safety rules stated in this instruction manual may cause serious personal injury.**

ENC007-4

## IMPORTANT SAFETY INSTRUCTIONS

### FOR BATTERY CARTRIDGE

1. **Before using battery cartridge, read all instructions and cautionary markings on (1) battery charger, (2) battery, and (3) product using battery.**
2. **Do not disassemble battery cartridge.**
3. **If operating time has become excessively shorter, stop operating immediately. It may result in a risk of overheating, possible burns and even an explosion.**
4. **If electrolyte gets into your eyes, rinse them out with clear water and seek medical attention right away. It may result in loss of your eyesight.**
5. **Do not short the battery cartridge:**
  - (1) **Do not touch the terminals with any conductive material.**
  - (2) **Avoid storing battery cartridge in a container with other metal objects such as nails, coins, etc.**
  - (3) **Do not expose battery cartridge to water or rain.**

A battery short can cause a large current flow, overheating, possible burns and even a breakdown.
6. **Do not store the tool and battery cartridge in locations where the temperature may reach or exceed 50 ° C (122 ° F).**
7. **Do not incinerate the battery cartridge even if it is severely damaged or is completely worn**

- 
- out. The battery cartridge can explode in a fire.
  8. Be careful not to drop or strike battery.
  9. Do not use dropped or struck battery.

## **SAVE THESE INSTRUCTIONS.**

### **Tips for maintaining maximum battery life**

1. Charge the battery cartridge before completely discharged.  
Always stop tool operation and charge the battery cartridge when you notice less tool power.
2. Never recharge a fully charged battery cartridge.  
Overcharging shortens the battery service life.
3. Charge the battery cartridge with room temperature at 10 ° C - 40 ° C (50 ° F - 104 ° F).  
Let a hot battery cartridge cool down before charging it.

## Parts supplied

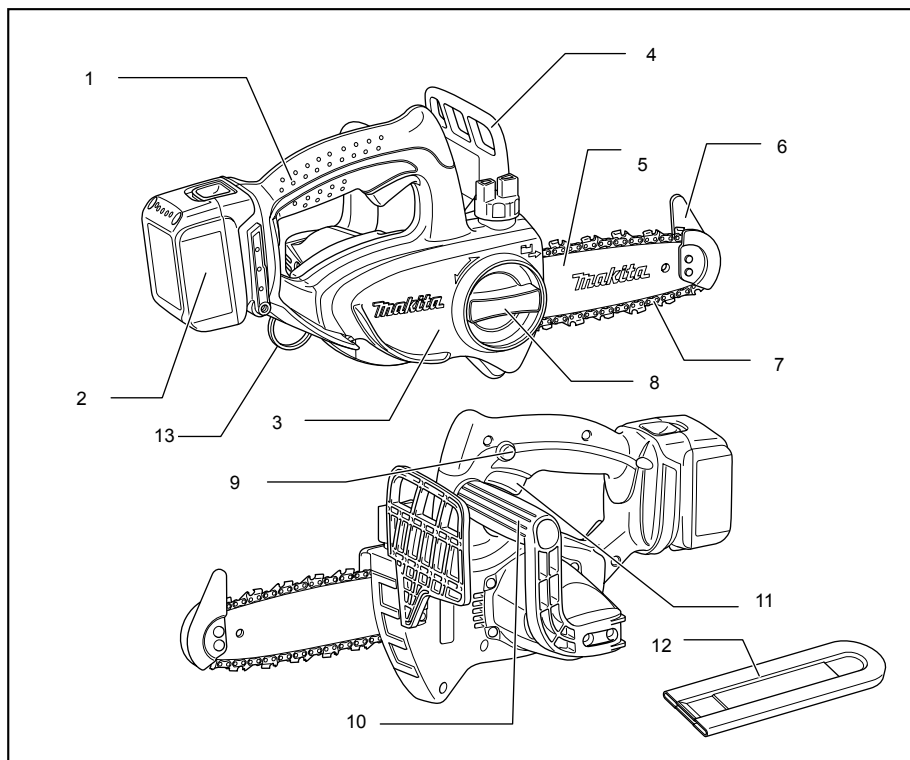

008588

1	Top handle	8	knob
2	Battery cartridge	9	Lock off button
3	Sprocket cover	10	Front handle
4	Front hand guard	11	Switch trigger
5	Guide bar	12	Chain cover
6	Tip guard	13	Carabiner or rope attachment point
7	Saw chain		

008589



## FUNCTIONAL DESCRIPTION

### ⚠CAUTION:

- Always be sure that the tool is switched off and the battery cartridge is removed before adjusting or checking function on the tool.

### Installing or removing battery cartridge

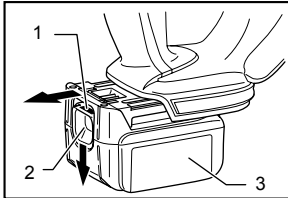

1. Red part
2. Button
3. Battery cartridge

008565

- Always switch off the tool before installation or removal of the battery cartridge.
- To remove the battery cartridge, withdraw it from the tool while sliding the button on the front of the cartridge.
- To insert the battery cartridge, align the tongue on the battery cartridge with the groove in the housing and slip it into place. Always insert it all the way until it locks in place with a little click. If you can see the red part on the upper side of the button, it is not locked completely. Insert it fully until the red part cannot be seen. If not, it may accidentally fall out of the tool, causing injury to you or someone around you.
- Do not use force when inserting the battery cartridge. If the cartridge does not slide in easily, it is not being inserted correctly.

### Switch action

### ⚠CAUTION:

- Before inserting the battery cartridge into the tool, always check to see that the switch trigger actuates properly and returns to the "OFF" position when released.

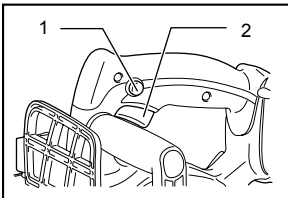

1. Lock-off button
2. Switch trigger

008572

To prevent the switch trigger from being accidentally pulled, a lock-off button is provided.

To start the tool, depress the lock-off button and pull the switch trigger. Release the switch trigger to stop.

## ASSEMBLY

### ⚠CAUTION:

- Always be sure that the tool is switched off and the battery cartridge is removed before carrying out any work on the tool.

### Installing or removing saw chain

### ⚠CAUTION:

- Always be sure that the tool is switched off and the battery cartridge is removed before installing or removing the saw chain.
- Always wear gloves when installing or removing the saw chain.
- Use only saw chain and guide bar with bar tip designed for this chain saw (see the Extract from the spare parts list).
- In order to prevent kickback, do not remove the bar tip or replace the guide bar with one without a bar tip.

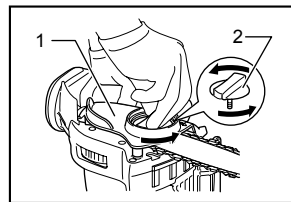

1. Sprocket cover
2. Knob

008566

Loosen the screw by turning counterclockwise the knob until the sprocket cover comes off.

Remove the sprocket cover.

Remove saw chain and guide bar from the tool.

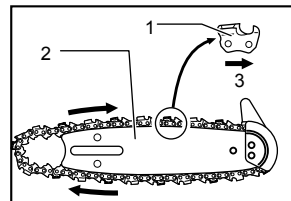

1. Cutter
2. Guide bar
3. Arrow

008568

Fit in one end of the saw chain on the top of guide bar. At this time, fit the saw chain as shown in the figure because it rotates in the direction of arrow.

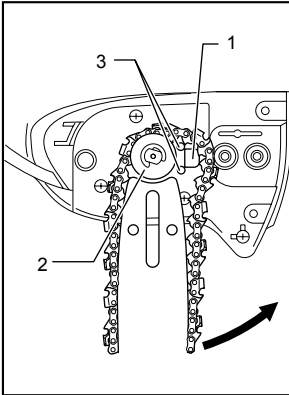

1. Spring
2. Sprocket
3. Boss

008630

Place the saw chain so that the spring and boss are positioned inside it and fit in the other end of saw chain around the sprocket as shown in the figure.

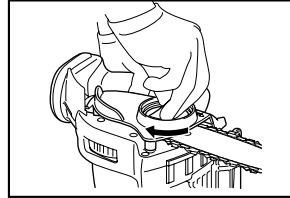

008570

Turn the knob clockwise to tighten the screw firmly.

### Adjusting saw chain tension

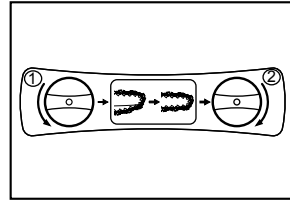

008587

Just a slight loosening of the screw allows the saw chain tension to be adjusted. After adjusting, retighten the screw firmly.

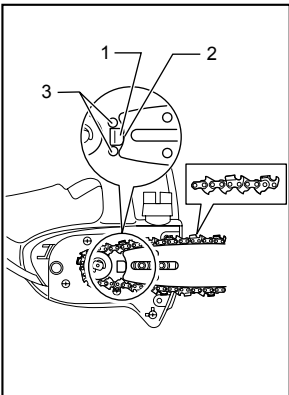

1. Spring
2. Guide bar
3. Boss

008631

While turning the guide bar counterclockwise, install it so that the end of guide bar contacts the spring.

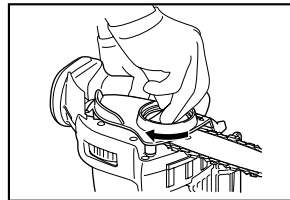

008570

### ⚠ CAUTION:

- For a while after a new saw chain is installed, it tends to become loosened. From time to time check the saw chain tension before use.
- Low tension of saw chain may cause coming out of place.
- Installing or removing saw chain should be carried out in a clean place free from sawdust and the like.

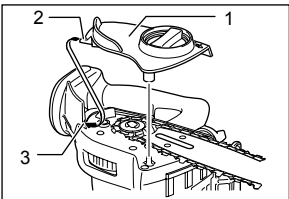

1. Sprocket cover
2. Hook
3. Hole

008569

Insert the hook of sprocket cover into the hole in the tool and then place the sprocket cover on the tool.

# OPERATION

## Lubrication

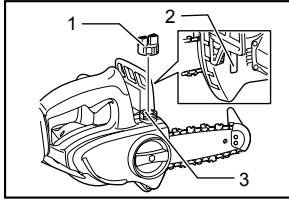

1. Oil tank cap
2. Oil inspection window
3. Oil tank opening

008571

Saw chain is automatically lubricated when the tool is in operation.

Check the amount of remaining oil in the oil tank through the oil inspection window.

To refill the tank, remove the cap from the oil tank opening. The oil tank capacity is 80 ml.

After refilling the tank, always screw the provided oil tank cap on the chain saw.

### ⚠ CAUTION:

- When filling the chain saw with chain oil for the first time, or refilling the tank after it has been completely emptied, add oil up to the bottom edge of the filler neck. The oil delivery may otherwise be impaired.
- As a saw chain oil, use oil exclusively for Makita chain saws or oil available in market.
- Never use oil including dust and particles or volatile oil.
- When pruning trees, use botanical oil. Mineral oil may harm trees.
- Never force the chain saw when pruning trees.
- Before cutting out, make sure that the provided oil tank cap is screwed in place.

Hold the chain saw away from the tree. Start it and wait until lubrication on saw chain is adequate.

Bring the tip guide/lower guide into contact with the branch to be cut before switching on. Cutting without bringing the tip guide/lower guide into contact with the branch may cause the guide bar to wobble, resulting in injury to operator.

Saw the wood to be cut by just moving it down.

## Pruning trees

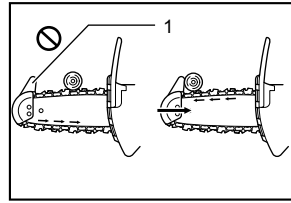

1. Tip guide

008574

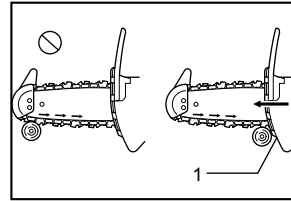

1. Lower guide

008575

### ⚠ CAUTION:

- Keep all parts of the body away from the saw chain when the motor is operating.
- Hold the chain saw firmly with both hands when the motor is running.
- Do not overreach. Keep proper footing and balance at all times.

Bring the tip guide/lower guide into contact with the branch to be cut before switching on. Cutting without bringing the tip guide/lower guide into contact with the branch may cause the guide bar to wobble, resulting in injury to operator.

When cutting thick branches, first make a shallow undercut and then make the finish cut from the top.

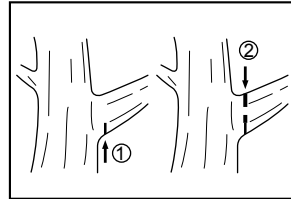

008576

If you try to cut off thick branches from the bottom, the branch may close in and pinch the saw chain in the cut. If you try to cut off thick branches from the top without a shallow undercut, the branch may splinter.

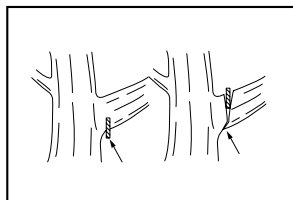

001742

If you cannot cut the timber right through with a single stroke:

Apply light pressure to the handle and continue sawing and draw the chain saw back a little; then apply the spike a little lower and finish the cut by raising the handle.

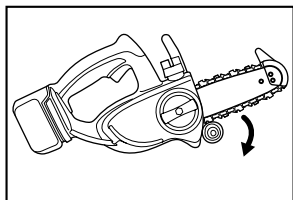

008634

### Carrying tool

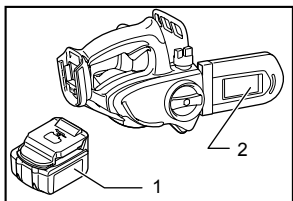

008573

Always remove the battery cartridge from the tool and overlap the guide bar with the scabbard before carrying the tool. Also cover the battery cartridge with the battery cover.

## MAINTENANCE

### ⚠CAUTION:

- Always be sure that the tool is switched off and the battery cartridge is removed before attempting to perform inspection or maintenance.
- Always wear gloves when performing any inspection or maintenance.
- Never use gasoline, benzine, thinner, alcohol or the like. Discoloration, deformation or cracks may result.

### Sharpening the saw chain

#### ⚠CAUTION:

- Always remove the battery cartridge and wear safety gloves when performing work on the saw chain.

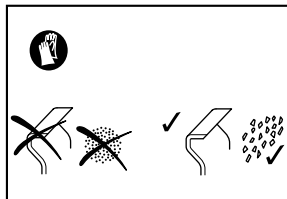

008633

#### Sharpen the saw chain when:

- Mealy sawdust is produced when damp wood is cut;
- The chain penetrates the wood with difficulty, even when heavy pressure is applied;
- The cutting edge is obviously damaged;
- The saw pulls to the left or right in the wood. The reason for this behaviour is uneven sharpening of the saw chain, or damage to one side only.

#### Sharpen the saw chain frequently, but remove only a little material each time.

Two or three strokes with a file are usually sufficient for routine reshaping. When the saw chain has been reshaped several times, have it sharpened in a MAKITA specialist repair shop.

#### File and file guiding

- Use a special round file (optional accessory) for saw chains, with a diameter of 4 mm, to sharpen the chain. Normal round files are not suitable.

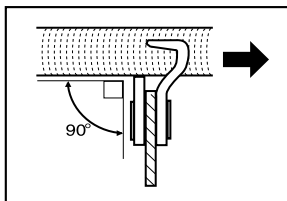

006927

- The file should only engage the material on the forward stroke. Lift the file off the material on the return stroke.
- Sharpen the shortest cutter first. The length of this cutter is then the gauge dimension for all other cutters on the saw chain.
- Guide the file as shown in the figure.
- The file can be guided more easily if a file holder (accessory) is employed. The file holder has markings for the correct sharpening angle of 30 °

(align the markings parallel to the saw chain) and limits the depth of penetration (to 4/5 of the file diameter).

Guide the file as shown in the figure.

- After sharpening the chain, check the height of the depth gauge using the chain gauge tool (optional accessory).

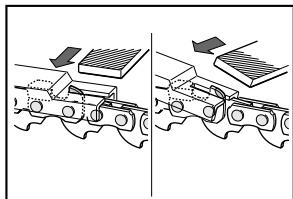

006929

- Remove any projecting material, however small, with a special flat file (optional accessory).
- Round off the front of the depth gauge again.
- Wash away dust and particles from saw chain after adjusting the height of depth gauge.

### Cleaning guide bar

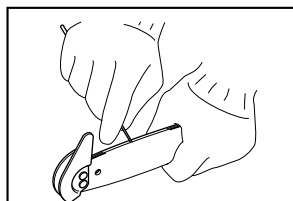

008578

Chips and sawdust will build up in the guide bar groove, clogging it and impairing oil flow. Always clean out the chips and sawdust when sharpening or replacing the saw chain.

### Cleaning the oil filter at the oil discharge hole

Small dust or particles may be built up in the oil filter at the oil discharge hole during operation.

Small dust or particles built up in the oil filter may impair the oil discharge flow and cause an insufficient lubrication on the whole saw chain.

When a poor chain oil delivery occurs at the top of guide bar, clean the filter as follows.

Remove the battery cartridge from the tool.

Remove the sprocket cover and saw chain from the tool. (Refer to the section titled "Installing or removing saw chain".)

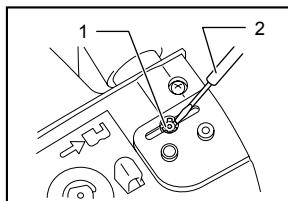

008579

Remove the push nut using a slotted bit screwdriver with a slender shaft or the like.

1. Push nut
2. Slotted bit screwdriver

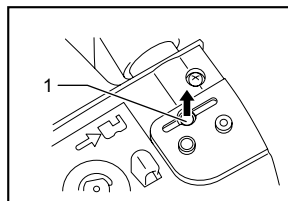

008580

Take the filter out of the chain saw and remove small dust or particles from it. When the filter is too dirty, replace it with a new one.

Insert the battery cartridge into the tool.

1. Filter

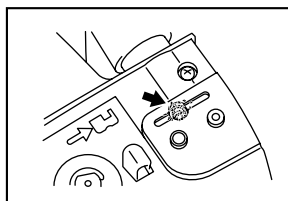

008581

Pull the switch trigger to flow built-up dust or particles off the oil discharge hole by discharging chain oil. Remove the battery cartridge from the tool.

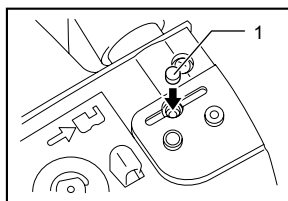

008582

Insert the cleaned oil filter into the oil discharge hole. When the filter is too dirty, replace it with a new one.

1. Filter

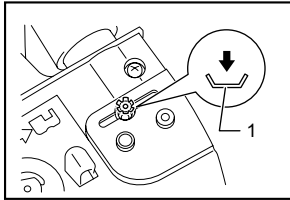

1. Push nut

008635

Insert the push nut with its correct side facing up as shown in the figure into the oil discharge hole to secure the filter. When the filter cannot be secured with a disfigured push nut, replace the push nut with a new one. Reinstall the sprocket cover and saw chain on the tool.

### Replacing the sprocket

Before fitting a new saw chain, check the condition of the sprocket.

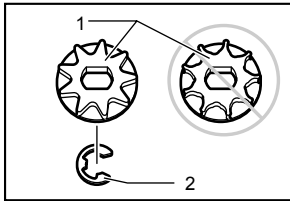

1. Sprocket  
2. Locking ring

008584

#### ⚠ CAUTION:

- A worn sprocket will damage a new saw chain. Have the sprocket replaced in this case. The sprocket need to be installed so that it always faces as shown in the figure.

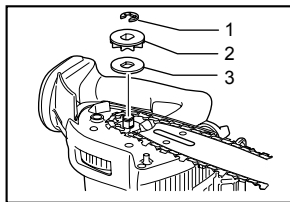

1. Locking ring  
2. Sprocket  
3. Washer

008586

Always fit a new locking ring when replacing the sprocket.

### Replacing carbon brushes

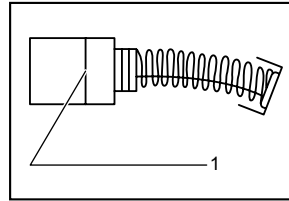

1. Limit mark

001145

Remove and check the carbon brushes regularly. Replace when they wear down to the limit mark. Keep the carbon brushes clean and free to slip in the holders. Both carbon brushes should be replaced at the same time. Use only identical carbon brushes.

Use a screwdriver to remove the brush holder caps. Take out the worn carbon brushes, insert the new ones and secure the brush holder caps.

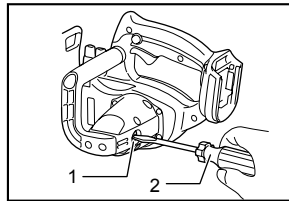

1. Brush holder cap  
2. Screwdriver

008585

### Storing tool

Clean the tool before storing. Remove any chips and sawdust from the tool after removing the sprocket cover. After cleaning the tool, run it under no load to lubricate the saw chain and guide bar.

Cover the guide bar with the scabbard.

Remove oil from the oil tank to empty it and place the chain saw with the tank cap facing upward.

To maintain product SAFETY and RELIABILITY, repairs, any other maintenance or adjustment should be performed by Makita Authorized Service Centers, always using Makita replacement parts.

## ACCESSORIES

#### ⚠ CAUTION:

- These accessories or attachments are recommended for use with your Makita tool specified in this manual. The use of any other accessories or attachments might present a risk of injury to persons. Only use accessory or attachment for its stated purpose.

If you need any assistance for more details regarding these accessories, ask your local Makita Service Center.

- 
- Various type of Makita genuine batteries and chargers
  - Saw chain
  - Scabbard
  - Guide bar complete
  - File

Makita Corporation Anjo, Aichi, Japan